

Top Pivot

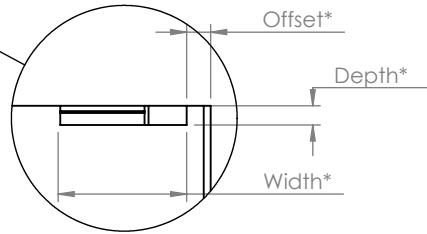

Intermediate Pivot

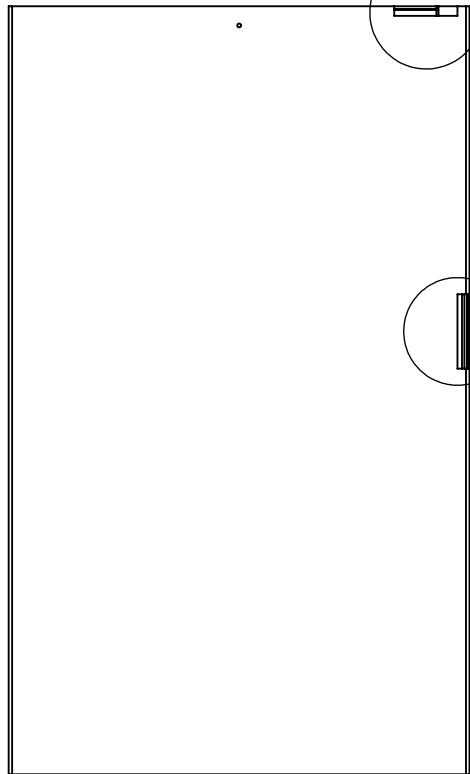
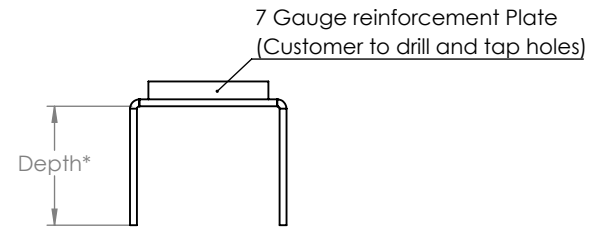
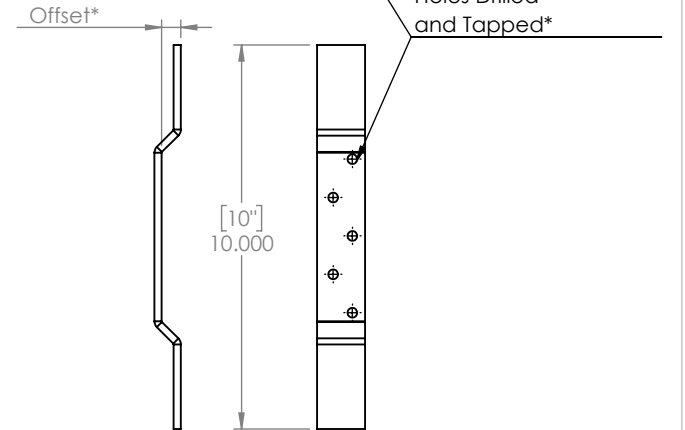
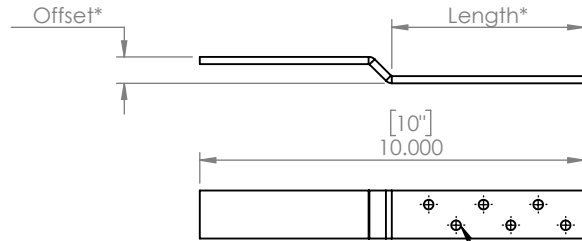
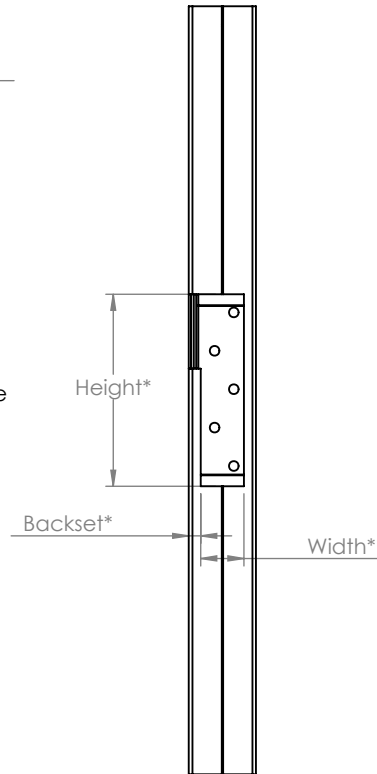
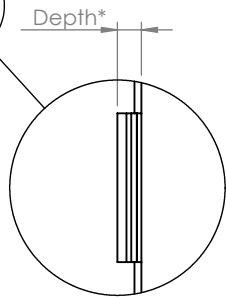

Bottom Pivot

*Dimensions determined by templates

REVISIONS		
No.	DESCRIPTION	DATE



1701 East 22nd Street Little Rock, AR 72206
 TEL: 501.372.3441 800.334.3070 FAX: 501.375.3070
 email: NCHMetal.com

TITLE: Detail Door Top, Bottom & Intermediate Pivot

UNLESS OTHERWISE SPECIFIED ALL DIMENSIONS ARE IN INCHES
 *Dimensions determined by pivot template

Pivot Reinforcements and Cutouts Doors

Drawn by: K. Jelley	Date: 03-23-18
DRAWING No. 021	SHEET 021 of 027